

Please order by parts number, not key number
Veuillez indiquer le numéro de la pièce (Non "Key" No.)

LEGALIS SPINNING REEL

LEGALIS 1000SH/1500SH/2000SH/2500SH/ 3000SH/3500SH/4000SH

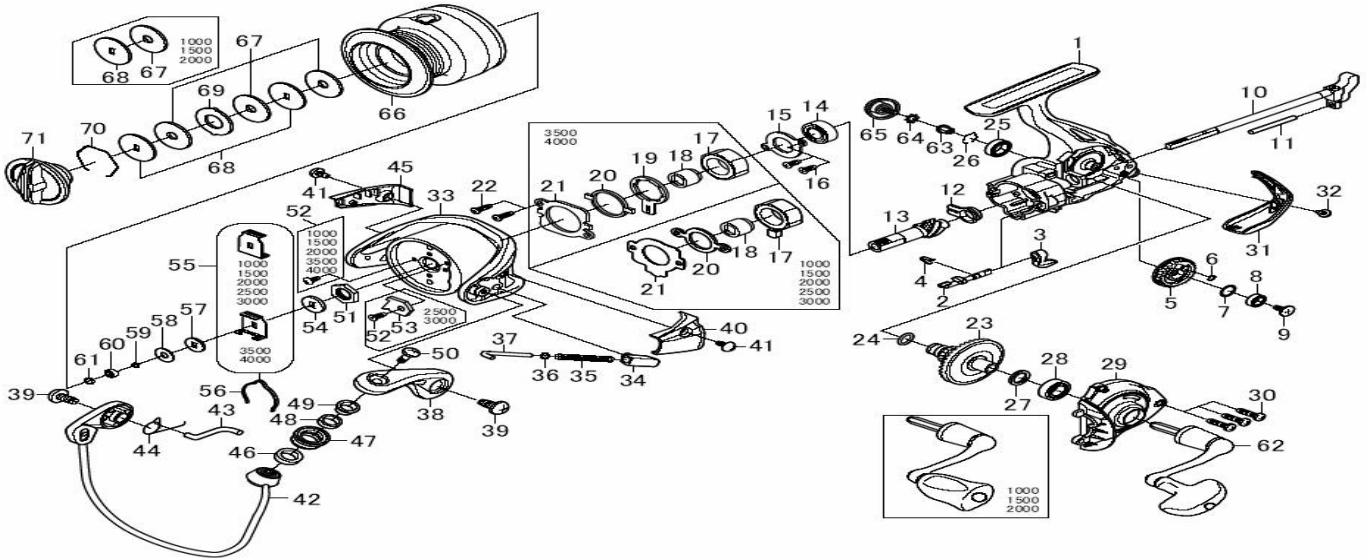

Key No.	1000SH Parts No.	Parts Name	1500SH Parts No.	2000SH Parts No.	2500SH Parts No.	3000SH Parts No.	3500SH Parts No.	4000SH Parts No.
1	H73-3001	Body	H73-3001	H73-3001	H73-2301	H73-2301	H73-4701	H73-4701
2	H46-3101	Anti-Reverse Cam	H46-3101	H46-3101	H46-3101	H46-3101	H50-8301	H50-8301
3	H46-3207	Anti-Reverse Lever	H46-3207	H46-3207	H46-3207	H46-3207	H46-3207	H46-3207
4	H40-3301	Anti-Reverse Cam Spring	H40-3301	H40-3301	H40-3301	H40-3301	H40-3301	H40-3301
5	H49-5801	Oscillating Gear	H49-5801	H49-5801	H48-9801	H48-9801	H54-5301	H54-5301
6	G68-3301	"O" Ring (A)	G68-3301	G68-3301	G46-6001	G46-6001	B85-3101	B85-3101
7	G46-6100	Washer (A)	G46-6100	G46-6100	G46-6100	G46-6100	G52-2100	G52-2100
8	F05-5502	Ball Bearing (A)	F05-5502	F05-5502	F05-5502	F05-5502	G46-7102	G46-7102
9	H46-3401	Screw (A)	H46-3401	H46-3401	H46-3401	H46-3401	H46-3401	H46-3401
10	H73-3301	Main Shaft	H73-3301	H73-3301	H73-2501	H73-2501	H73-4601	H73-4601
11	H49-4201	Stabilizer Bar	H49-4201	H49-4201	H46-3701	H46-3701	H50-8601	H50-8601
12	H40-3801	Collar (A)	H40-3801	H40-3801	H40-3801	H40-3801	H50-8901	H50-8901
13	H73-3401	Pinion Gear	H73-3401	H73-3401	H54-3702	H54-3702	H54-4603	H54-4603
14	H72-6801	Ball Bearing (B)	H72-6801	H72-6801	H72-6801	H72-6801	H73-5001	H73-5001
15	H46-3901	Bearing Retainer (A)	H46-3901	H46-3901	H46-3901	H46-3901	H50-9101	H50-9101
16	H62-4901	Screw (B)	H62-4901	H62-4901	H62-4901	H62-4901	H62-4901	H62-4901
17	G53-9201	Roller Clutch	G53-9201	G53-9201	G53-9201	G53-9201	G31-4501	G31-4501
18	H62-4702	Spacing Sleeve	H62-4702	H62-4702	H62-4702	H62-4702	G74-3003	G74-3003
19	-	Clutch Cam	-	-	-	-	F64-1401	F64-1401
20	H16-1801	Clutch Cam Retainer	H16-1801	H16-1801	H16-1801	H16-1801	F64-1501	F64-1501
21	H46-4001	Roller Clutch Retainer	H46-4001	H46-4001	H46-4001	H46-4001	H51-5001	H51-5001
22	G83-7101	Screw (C)	G83-7101	G83-7101	G83-7101	G83-7101	G83-7101	G83-7101
23	H73-3501	Drive Gear	H73-3501	H73-3501	H72-6901	H72-6901	H73-5101	H73-5101
24	G67-0501	"O" Ring (B)	G67-0501	G67-0501	G67-0501	G67-0501	G64-5301	G64-5301
25	G52-2703	Ball Bearing (C)	G52-2703	G52-2703	G52-2703	G52-2703	R86-1704	R86-1704
26	G47-2401	Bearing Retainer (B)	G47-2401	G47-2401	G47-2401	G47-2401	G52-5101	G52-5101
27	375-8500	Washer (B)	375-8500	375-8500	375-8500	375-8500	373-7800	373-7800
28	G46-7302	Ball Bearing (D)	G46-7302	G46-7302	G46-7302	G46-7302	G52-3401	G52-3401
29	H73-3601	Side Cover	H73-3601	H73-3601	H73-2401	H73-2401	H73-5201	H73-5201
30	G11-5001	Screw (D)	G11-5001	G11-5001	G11-5001	G11-5001	G11-5001	G11-5001
31	H49-4701	Rear Cover	H49-4701	H49-4701	H46-4301	H46-4301	H50-9501	H50-9501
32	G27-0801	Screw (E)	G27-0801	G27-0801	G27-0801	G27-0801	G27-0801	G27-0801
33	H49-4804	Rotor	H49-4804	H49-4804	H46-4408	H46-4408	H50-9605	H50-9605
34	H49-6701	Bail Spring Holder	H49-6701	H49-6701	H49-6701	H49-6701	H50-9701	H50-9701
35	G47-1701	Bail Spring	G47-1701	G47-1701	G47-1701	G47-1701	G64-6201	G64-6201
36	E31-3901	Washer (C)	E31-3901	E31-3901	E31-3901	E31-3901	E31-3901	E31-3901
37	G47-1805	Bail Spring Shaft	G47-1805	G47-1805	G47-1805	G47-1805	G29-8201	G29-8201
38	H46-4507	Bail Arm	H46-4507	H46-4507	H46-4507	H46-4507	H46-4507	H46-4507
39	G20-5001	Screw (F)	G20-5001	G20-5001	G20-5001	G20-5001	G20-5001	G20-5001
40	H49-7901	Cover (A)	H49-7901	H49-7901	H49-8001	H49-8001	H50-9801	H50-9801
41	G27-0801	Screw (G)	G27-0801	G27-0801	G27-0801	G27-0801	G27-0801	G27-0801
42	C72-5001	Bail Assembly	C72-5001	C72-5001	C70-3401	C70-3401	C74-3601	C74-3601
43	C63-0801	Bail Trip Lever	C63-0801	C63-0801	C61-3001	C61-3001	C64-6501	C64-6501
44	G61-3101	Bail Trip Lever Spring	G61-3101	G61-3101	G61-3101	G61-3101	G61-3101	G61-3101
45	H49-8001	Cover (B)	H49-8001	H49-8001	H49-6901	H49-6901	H51-0101	H51-0101
46	G87-4201	Collar (B)	G87-4201	G87-4201	G87-4201	G87-4201	G87-4201	G87-4201
47	F82-5001	Line Roller	F82-5001	F82-5001	F82-5001	F82-5001	F82-5001	F82-5001
48	G87-4301	Collar (C)	G87-4301	G87-4301	G87-4301	G87-4301	G87-4301	G87-4301
49	G15-2503	Collar (D)	G15-2503	G15-2503	G15-2503	G15-2503	G15-2503	G15-2503
50	G19-5602	Screw (H)	G19-5602	G19-5602	G19-5602	G19-5602	G19-5602	G19-5602
51	H71-1901	Rotor Nut	H71-1901	H71-1901	H71-1901	H71-1901	H51-0201	H51-0201
52	G62-7701	Screw (I)	G62-7701	G62-7701	H62-4901	H62-4901	G62-7701	G62-7701
53	-	Rotor Plate	-	-	H69-7901	H69-7901	-	-
54	E24-6101	Washer (D)	E24-6101	E24-6101	E24-6101	E24-6101	E24-6101	E24-6101
55	G70-0001	Click Leaf Spring Holder	G70-0001	G70-0001	G70-0001	G70-0001	G74-3901	G74-3901
56	H57-0801	Spool Click Leaf Spring	H57-0801	H57-0801	H57-0801	H57-0801	F70-9002	F70-9002
57	E46-7101	Washer (E)	E46-7101	E46-7101	E46-7101	E46-7101	E46-7101	E46-7101
58	E39-8000	Washer (F)	E39-8000	E39-8000	E39-8000	E39-8000	E39-8000	E39-8000
59	B41-1706	Washer (G)	B41-1706	B41-1706	B41-1706	B41-1706	B41-1706	B41-1706
60	C90-8801	Ball Bearing (E)	C90-8801	C90-8801	C90-8801	C90-8801	C90-8801	C90-8801
61	G21-3001	"O" Ring (C)	G21-3001	G21-3001	G21-3001	G21-3001	G21-3301	G21-3301
62	H73-3701	Handle Assembly	H73-3701	H73-3701	H72-7001	H72-7001	H73-5301	H73-5301
63	F72-1001	Collar (E)	F72-1001	F72-1001	F72-1001	F72-1001	F72-1202	F72-1202
64	160-8101	Washer (H)	160-8101	160-8101	160-8101	160-8101	160-8101	160-8101
65	H46-5501	Handle Screw	H46-5501	H46-5501	H46-5501	H46-5501	H51-0901	H51-0901
66-70	H73-3901	Spool Assembly	H73-3901	H73-3901	H72-7201	H72-7201	H73-5501	H73-5501
67	E13-6001	Washer (I)	E13-6001	E13-6001	E13-6001	E13-6001	E13-6001	E13-6001
68	E46-7201	Washer (J)	E46-7201	E46-7201	E46-7201	E46-7201	E46-7201	E46-7201
69	-	Washer (K)	-	-	373-3606	373-3606	373-3606	373-3606
70	F37-3301	Drag Washer Retainer	F37-3301	F37-3301	F37-3301	F37-3301	F37-3301	F37-3301
71	Q05-5701	Drag Knob	Q05-5701	Q05-5701	Q05-6201	Q05-6201	Q05-6201	Q05-6201